

Starke

Fișă tehnică produs ST00351

PROIECTOR LED 20W CU SENZOR



Senzor de mișcare integrat

Tip: senzor microunde

Caracteristici

- Greutate și dimensiune optimizate datorită designului compact
- Disponibil cu unghi de fascicul: 120°
- Lumină omogenă

Dimensiuni

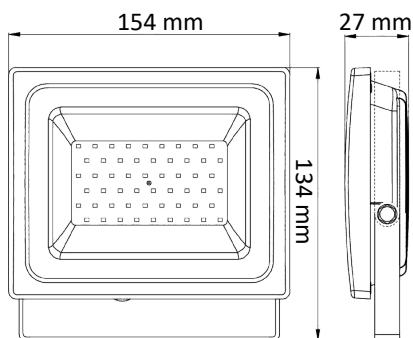

Specificații tehnice

Aplicații	Parcări, treceri subterane, garaje, grădini
Grad de protecție	IP65
Tensiune de alimentare	185-265V / 50-60 Hz
Putere	20 W
Flux luminos	2000 lm
Unghi fascicul	120°
Randamentul corpului de iluminat	100 lm/W
Temperatură de culoare	6500 K
Carcasă	Aluminiu
Factor putere	>0.90
Durata de viață	30.000 h
Cod produs	ST00351

